

CORNISH CONCRETE PRODUCTS

# CROSSWALL CONSTRUCTION LOW CARBON FAST TRACK BUILDINGS >



- / BASEMENTS
- / DOUBLE WALLS
- / CROSSWALL
- / THERMOFLOOR
- / THERMOWALL
- / STAIRS



**PROJECT:** Penwith College  
**PRODUCT:** Thermowall Panels

## Looking for green, innovative, efficient building solutions?

When considering low carbon buildings, the choice of building fabric is essential in determining the performance of the structure. There are a number of factors which will have a significant effect on performance.

- / Orientation and siting of the building
- / Thermal mass
- / Solar shading
- / Natural ventilation
- / Good insulation values
- / Excellent air tightness
- / No cold bridging

CCP Crosswall Construction including Thermowall and Thermofloor Panels is a fast, efficient and robust form of construction. When coupled with good passive design, CCP Crosswall Construction can deliver the high performance low carbon buildings of the future. Alternatively, elements of this construction can be mixed and matched with other elements to help improve the structural performance of the building.

Far from inhibiting choice, Crosswall Solutions can create a positive framework for buildings to meet our ever changing needs.

## What is thermal mass?

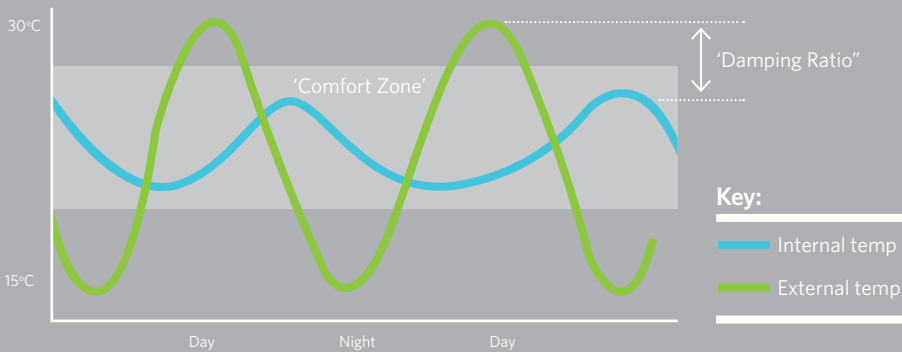

This graph illustrates the damping effect that the exposed thermal mass within the fabric of a building has on the external temperature.

Thermal mass is the ability of a material to absorb heat. A lot of heat energy is required to change the temperature of a high-density material like concrete. High thermal mass, low conductivity materials, act as thermal sponges, absorbing heat during the summer to cool the building, and store heat from the sun or heaters to release it at night.

### Why is it important?

The thermal capacity of concrete structures can be utilised to improve the energy efficiency of buildings. Compared to air conditioning, Active Fabric Energy Storage reduces carbon dioxide emissions by up to 50%. About 90% of the environmental impact from buildings is from heating, cooling and lighting, and only about 10% is from the embodied energy used to produce the fabric of the building itself (taken over a 60 year life-cycle).

### Which bits matter?

It is essential that the thermal mass of the material is exposed within the fabric of the building. In other words, concrete's ability to absorb energy would be compromised by placing an artificial layer made from a less dense material in front of it.

By adopting an environmentally responsible attitude towards the specification, design, and construction of our building, infrastructure and civil engineering projects, we can choose materials for all the right reasons.

Our environmental approach can have beneficial effects all the way through the life-cycle of a building or structure.

## Basements

CCP offer a complete design and detailing service through its in-house design team

### Construction Method

Precast basement units are manufactured with CCP's double wall construction method. Double walls are essentially a precast/insitu concrete hybrid which offer all of the advantages of precast concrete with the robustness that insitu concrete affords under the ground. Units comprise of two concrete leaves; typically 60mm thick connected with steel lattice girders. The product is relatively light as there is a cavity between the leaves which is filled with insitu concrete.

When the unit is installed, it is temporarily propped and connecting steel to other adjacent double wall units is placed in the cavity prior to concreting. Once the concrete has hardened, a single monolithic element is created. The process is fast and avoids expensive on site shuttering as the leaves act as permanent formwork. The units have an outstanding high quality factory surface finish which would be very

difficult to achieve with an insitu concrete solution.

In basement construction, excellent waterproofing is essential and the necessary waterstops and membranes can be incorporated into the design.

The double wall panels are fully detailed with respect to reinforcement, cast-in items and openings for windows, doors and services. Any wall geometry can be accommodated within the limits of the pallets on which they are manufactured. Electrical services can also be included in the pre-engineering of the panels at the design stage.

### Advantages of Basements:

- / More living space
- / Enhanced property values
- / Better utilisation of building land
- / Improved use of sites with difficult sloping land

### Typical Construction Sequence for a Double Wall:



1 / GF slab and starter bars

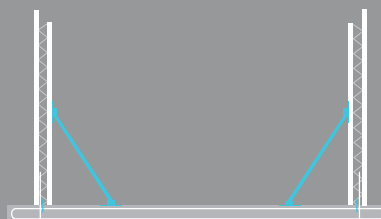

2 / Walls in place with props



The illustration shows a typical section through a double wall unit.

### Advantages of Double Wall Construction:

- / Considerable savings on main contract programme and preliminary costs such as scaffolding
- / Factory controlled conditions ensure accuracy and quality
- / Greatly reduced labour on site
- / Excellent acoustic characteristics
- / Excellent fire resistance, Class 0, BS8110:Part 2 or to Eurocode 2 Part 1-2
- / Immediate cosmetic finish, decor can be applied to both faces as soon as the building is watertight

- / Environmentally friendly - minimal of waste on site
- / System can be used for modular construction enabling buildings to be erected quickly

### Common uses for Double Walls

- / Shear walls
- / Staircore and lift shaft walls
- / Retaining walls
- / Permanent concrete formwork
- / Basement construction
- / Crosswall construction

### Options:

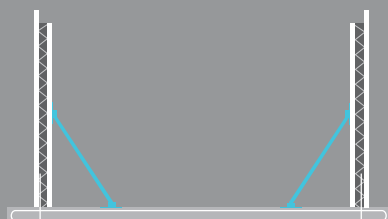

3 / Walls concreted

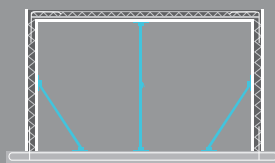

a / Demidec Slab - Propped then concreted

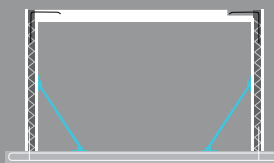

b / Solid/Hollow Core floor with grouted connections



## CCP Crosswall Construction offers excellent Air Tightness as a robust monolithic structure

### Crosswall Construction

CCP Crosswall Construction is a modern, fast and effective method of construction utilising precast concrete components.

Fabricated in a state of the art manufacturing facility, (the first of its kind in the UK) they can be designed on a bespoke basis for each and every project.

Crosswall construction has the ability to connect walls and floors together and thus avoid the need for a steel or concrete frame. Load bearing walls transmit vertical loads and act as shear walls to prevent lateral movement.

Lateral support can also be achieved by transmitting loads via the floor slab back to lift shafts, stair cores or other structural walls. Because there is no frame, there are no structural downstands required to accommodate beams. Whilst structures up to 16 storeys have been completed in the UK using this form of construction, it is just as suited to domestic housing. Indeed, by supplying a rigid framework for the building, lightweight partitions can be used internally which allow for maximum flexibility in the structure throughout its changing use over the lifecycle of the building whilst still retaining the essential fabric of the building.

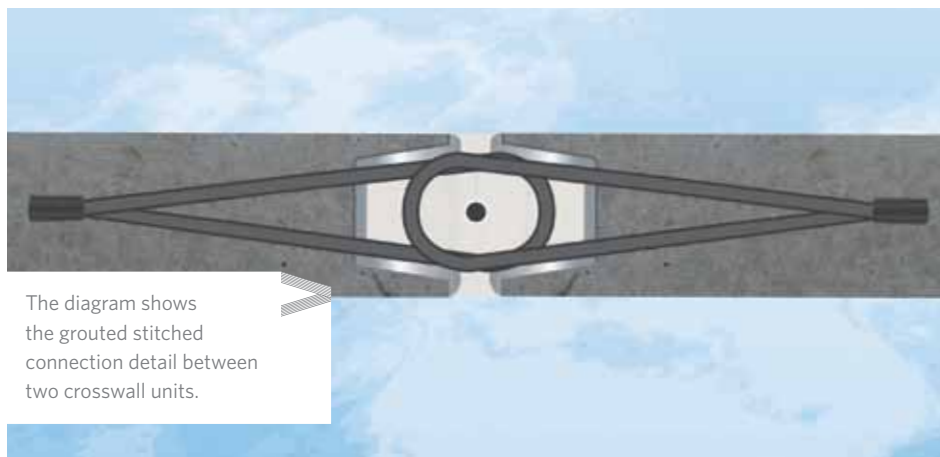

The diagram shows the grouted stitched connection detail between two crosswall units.

### Construction Method

Crosswall Panels are 'stitched' together on site at the joints by pouring a concrete grout into the reinforced joints of adjacent panels enabling continuity to be achieved. A small amount of internal decoration is required. This method of construction allows buildings to be erected faster than with using a conventional frame. Floor slabs are connected and grouted into the wall panels



### CCP Crosswall Construction further benefits:

- / Acoustic Separation is minimised due to the density of the floors and walls
- / Inherent thermal mass
- / Greater security
- / Reduced site co-ordination as many follow-on trades are eliminated
- / Reduced preliminary costs due to reduced programme times
- / Reduced heating and maintenance costs
- / Improved health and safety
- / No scaffold solution

# Crosswall Technical Details:

The illustrations below show upper floor connections:

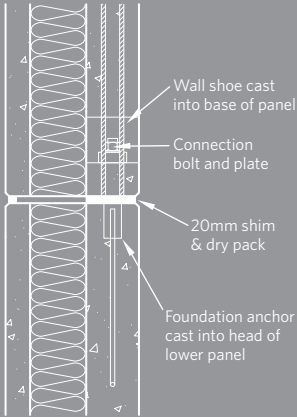

Typical Sandwich panel to panel horizontal joint using wall shoes

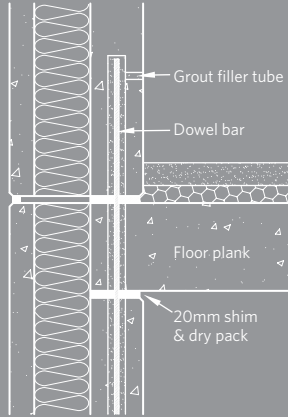

Typical Sandwich panel to panel horizontal joint using wall dowels

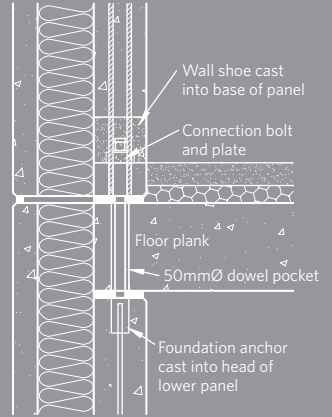

Typical Sandwich panel to panel horizontal joint using wall shoes

The illustrations below show ground floor connections:

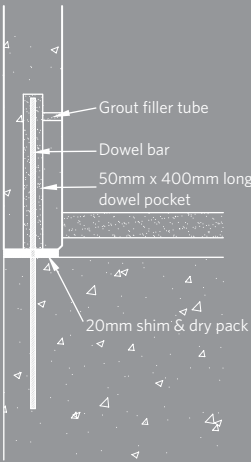

Typical unit base connection using starter bars

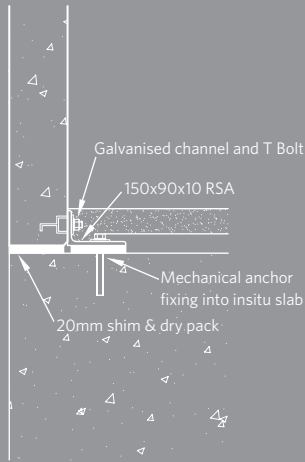

Typical unit base connection using fixing angles

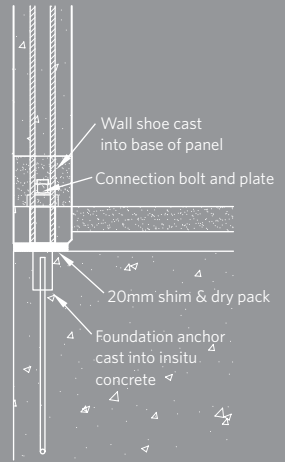

Typical unit base connection using wall shoes



## What is Thermofloor?

Thermofloor is an exposed flat soffit concrete flooring slab which is supplied by CCP to site ready for decoration. Widths of Thermofloor units can be varied to suit the geometry of the project. Joints between units can either be filled and smoothed prior to decoration or can be expressed as a feature.

### Why choose Thermofloor?

- / Excellent finish to units
- / No need for a suspended ceiling
- / Maximise thermal mass effect
- / Reduction in follow-on trades

### Thicknesses of Thermofloor?

Thermofloor Units are usually between 150mm and 200mm depending on the structural requirements, but can be made up to 500mm deep.

## Demidec Flooring

Alternatively, CCP can supply a thin decking slab which will provide the same quality of finish ready for an insitu concrete topping. This could also be used in conjunction with double walling to form a rigid monolithic box.

Demidec slabs are typically manufactured as 60mm deep with lattice girder reinforcement protruding from the slab which ties into the insitu concrete topping making a completely monolithic floor slab. These slabs are usually propped prior to the addition of the concrete topping, although can sometimes be designed without the need for props. See CCP's Demidec flooring brochure for more information.

Both Thermofloor options can be utilised in conjunction with CCP Crosswalls and Thermowall products as part of an overall Crosswall Construction.



## What are Thermowall Panels?

Thermowall Panels comprise of two layers of concrete with a layer of insulation sandwiched in between. They are connected together with non-metallic low conductivity ties to ensure that the panels remain thermally efficient and there is no 'cold bridging' between the layers.

Conventionally, the two skins of walls are connected with metallic ties which allow thermal bridging. CCP's Thermowall Panels replace these metallic ties with non-metallic connectors which have a conductivity value of  $0.3\text{W/m}^2\text{K}$  enhancing the performance of the insulation.

These connectors do not have the same constraints as blockwork ties and hence insulation thicknesses can be increased.

There is the potential to achieve 'U' values of  $0.1\text{W/m}^2\text{K}$  or below. The environmental benefits of this system over the life cycle of a building are enormous. Either as part of Crosswall Construction, or as fixed to a steel or concrete frame, Thermowall panels offer the chance to drive down a building's energy consumption levels compared to traditional construction. They achieve this by utilising the following factors inherent in their design:

- / Thermal mass
- / Good Insulation values
- / Excellent air tightness
- / No cold bridging
- / No Interstitial condensation



### Thermowall

The structural component of a Thermowall is the inner skin. This is normally 150mm thick and is reinforced with steel. The outer skin provides protection from the environment and can be produced to a variety of different finishes to meet the designer's requirements. These need not be limited to traditional architectural concrete finishes.



**PROJECT:** Office Development  
**PLACE:** Bracknell

## CCP's Quicklay Staircases are custom made to suit the client's requirements.

Staircases are made in modern variable steel moulds which allow the geometry of the staircase to be altered to suit a particular project.

They are fabricated with either flights supported off precast landings which are built in, or flights with quarter landings attached onto steelwork supports. All units can be offloaded and craned directly into place.

Precast flights are generally cast face down but can be cast on their side or face up to suit the client's requirements. If applied architectural finishes are needed, these can also be catered for, as well as non-slip strips. All Quicklay Staircases

can be provided with a F3/U3 finish. 'L' shaped tread and riser units are available and can be supported off blockwork walls each side. These are ideally suited to small works where no crane access is possible and for contracts with little or no repetition between units.

Alternatively, CCP can provide a feature staircase that makes an architectural statement of intent. This can either be in the form of a helical staircase with a multi-faceted soffit, an open tread staircase which allows light to permeate through or a spiral staircase where the smooth lines of the concrete are accentuated by the curve of the staircase.

# Environment and Quality

CCP takes its environmental responsibilities very seriously and is accredited with the Environmental Management System ISO14001. The company is also a founder signatory of the British Precast Sustainability Charter, and one of the first companies in the UK to be accredited with BE56001, the Code for Responsible Sourcing, achieving a "Very Good" status across its entire product range.

Furthermore, by choosing a precast concrete solution, the proliferation of waste and the risk of contamination are greatly reduced. Customers can take advantage of

the material's inherent thermal mass which when used within the internal fabric of a building acts as a dampening mechanism for the external temperature and hence reduces energy demand from heating and cooling.

CCP is also accredited with the Quality Management System ISO9001.



**Cornish Concrete Products Ltd**

Point Mills, Bissoe, Truro, Cornwall TR4 8QZ

**Tel: 01872 864808**

Email: [info@cornishconcrete.co.uk](mailto:info@cornishconcrete.co.uk)

**[www.cornishconcrete.co.uk](http://www.cornishconcrete.co.uk)**

**[www.ecocreteproducts.co.uk](http://www.ecocreteproducts.co.uk)**

